

VM 18



Camera a vuoto
ultra resistente



Pannello comandi
elettromeccanico



POMPA
100%
Made in Italy

Resistenza, solidità e durevolezza

"Programmazione manuale per rendere ancora una volta l'utente finale l'unico gestore di ogni processo di vuoto"

Realizzata totalmente in acciaio inox sia per quanto riguarda la carrozzeria che la camera a vuoto, VM 18 può confezionare alimenti anche all'esterno con l'ausilio dell'accessorio Easy. Consente di confezionare con estrema facilità, velocità e in totale igiene e sicurezza qualsiasi tipo di alimento e grazie alla valvola d'aspirazione esterna confezionare in contenitori sarà facilissimo!

VM 18 è ideale per:



Macellerie



Gastronomie



Laboratori alimentari

Metodi di confezionamento



Solo sigillatura



Vuoto

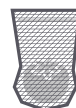

Vuoto esterno

□ Confezionatrice sottovuoto a campana

Caratteristiche tecniche

- > Carrozzeria: acciaio inox
- > Dimensioni: 582x574x496h mm
- > Dimensioni camera a vuoto: 448x440x185h mm
- > Peso: 72 kg
- > Tensione: 230V 50/60Hz
- > Potenza max assorbita: 1200 W
- > Barre saldanti: 1x 420 mm
2x 240 mm (su richiesta)
2x 345 + 1x 270 + 1x 310 mm (su richiesta)
- > Pompa di vuoto: 25 mc/h
- > Dimensione max busta: 400x500 mm
- > Interasse barre: 329 mm

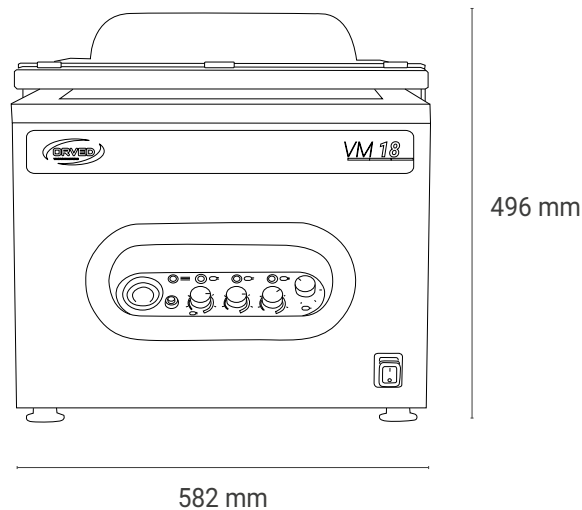



Dotazioni di serie

 Accessorio easy incluso

 H2out, ciclo deumidificazione pompa

Optional su richiesta

 Ugello per contenitori

 Softair

 Kit sacchetti lisci premium

Accessori abbinabili



Sacchetti sottovuoto lisci



Sacchetti sottovuoto gofrati



Sacchetti sottovuoto per cottura



Carrello



Contenitori Conserbox



Easy per vuoto esterno

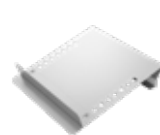

Ripiani inclinati per liquidi